



GRIDPRO Interchangeable Plates



GRIDPRO plates are all unfurnished for easy and quick configuration with the required modules.

The 1 to 24 Gang plates designed for GRIDPRO are available from each of the existing Click wiring accessory ranges. These new additions seamlessly match the range they belong to, including standard fixing centres allowing uniform alignment. All range finishes and warranties apply to the new GRIDPRO plates.

GRIDPRO Interchangeable Plates

Product Range

GRIDPRO Interchangeable Plates

CMA20401	1 Gang Mode Grid Plate
CMA20402	2 Gang Mode Grid Plate
CMA20403	3 Gang Mode Grid Plate
CMA20404	4 Gang Mode Grid Plate



CMA20401



CMA20402



CMA20403



CMA20404



Errors & Omissions excluded. Specification is subject to change without notice. Utilizes standard 1 gang and 2 gang BS4662 back boxes.

V1.0

Scolmore International Ltd, 1 Scolmore Park, Landsberg, Lichfield Road Ind. Estate, Tamworth, Staffordshire, B79 7XB

Telephone: 01827 63454

E-mail: sales@scolmore.com, technical@scolmore.com

Facsimile: 01827 63362

Website: www.scolmore.com

GRIDPRO Interchangeable Plates

Product Dimensional Drawings (mm)

CMA20401

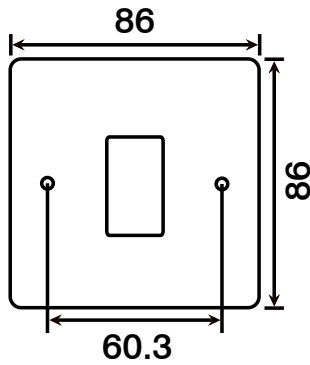

CMA20402

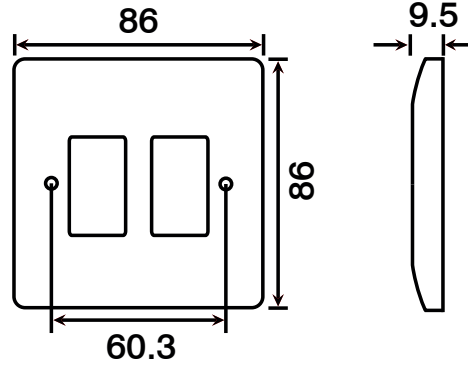

CMA20403

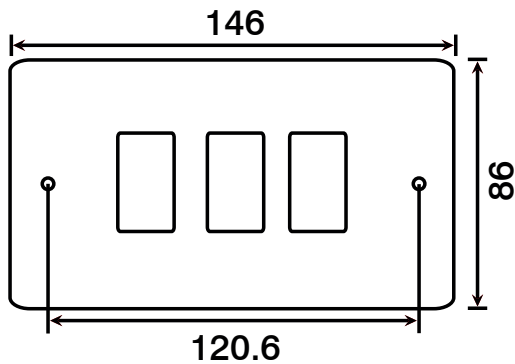

CMA20404

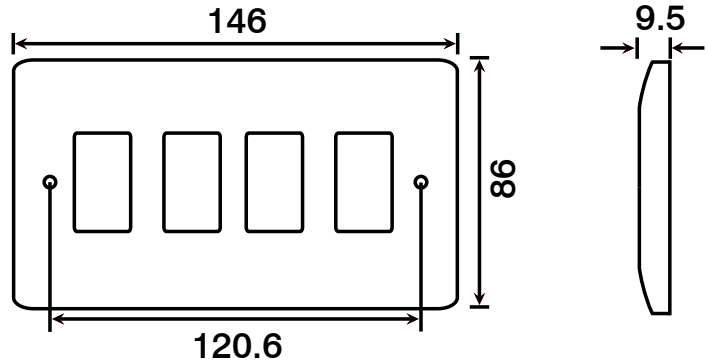

GRIDPRO Interchangeable Plates

Product Range

GRIDPRO Interchangeable Plates

CMA20506	6 Gang Mode Grid Plate
CMA20508	8 Gang Mode Grid Plate
GR20400	3 - 4 Module Yoke
WA512	2 Gang Double Row K/O Box 47mm Deep



CMA20506



CMA20508



GR20400

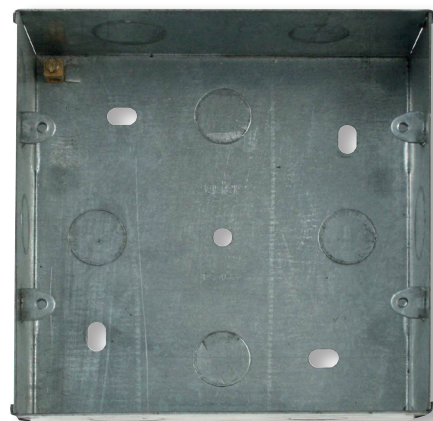

WA512



Errors & Omissions excluded. Specification is subject to change without notice. GR20400 to be used with all plate sizes.

V1.0

Scolmore International Ltd, 1 Scolmore Park, Landsberg, Lichfield Road Ind. Estate, Tamworth, Staffordshire, B79 7XB

Telephone: 01827 63454

E-mail: sales@scolmore.com, technical@scolmore.com

Facsimile: 01827 63362

Website: www.scolmore.com

GRIDPRO Interchangeable Plates

Product Range

GRIDPRO Interchangeable Plates

CMA20509	9 Gang Mode Grid Plate
CMA20512	12 Gang Mode Grid Plate
GR20400	3 - 4 Module Yoke
WA518	2 Gang Triple Row K/O Box 47mm Deep



CMA20509



CMA20512



GR20400

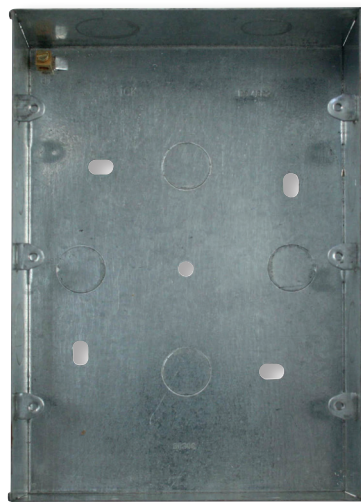

WA518



Errors & Omissions excluded. Specification is subject to change without notice. GR20400 to be used with all plate sizes.

V1.0

Scolmore International Ltd, 1 Scolmore Park, Landsberg, Lichfield Road Ind. Estate, Tamworth, Staffordshire, B79 7XB

Telephone: 01827 63454

E-mail: sales@scolmore.com, technical@scolmore.com

Facsimile: 01827 63362

Website: www.scolmore.com

GRIDPRO Interchangeable Plates

Product Dimensional Drawings (mm)

CMA20506

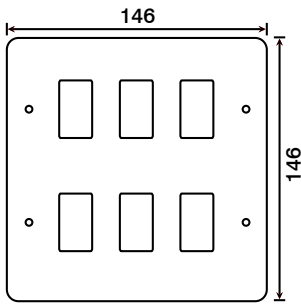

CMA20508

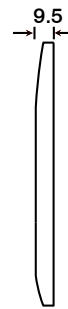
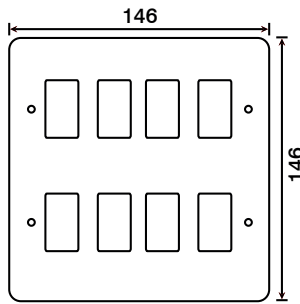

WA512

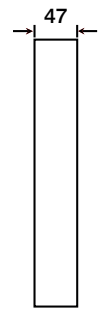
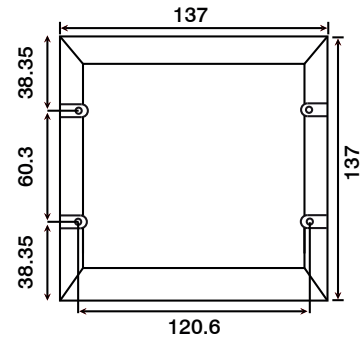

CMA20509

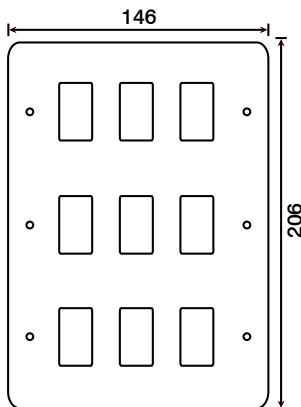

CMA20512

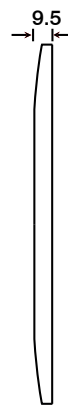
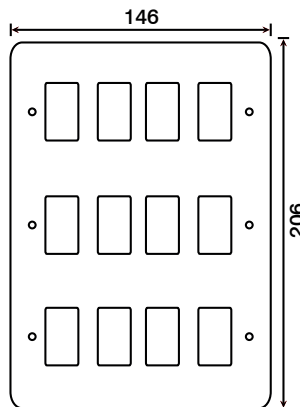

WA518

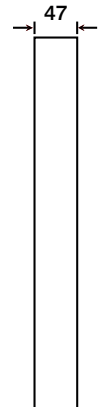
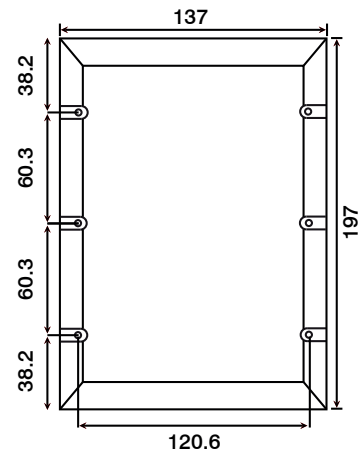

GR20400

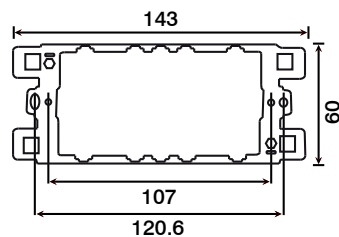

GRIDPRO Interchangeable Plates

Product Range

GRIDPRO Interchangeable Plates

CMA20518	18 Gang Mode Grid Plate
CMA20524	24 Gang Mode Grid Plate
GR20600	6 Module Yoke
WA20518	18 Gang K/O Box 56mm Deep
WA20524	24 Gang K/O Box 56mm Deep



CMA20518

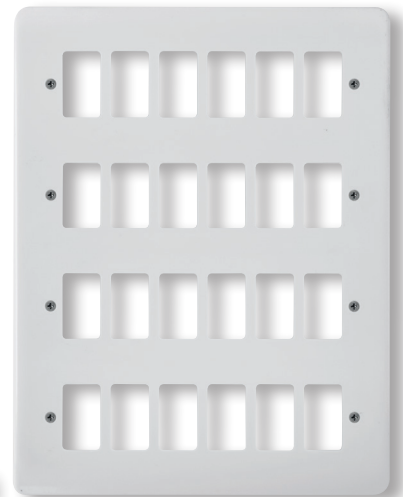

CMA20524



GR20600



WA20518



WA20524

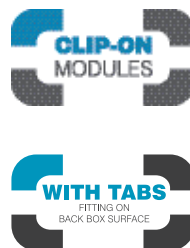

Errors & Omissions excluded. Specification is subject to change without notice. GR20600 to be used with all plate sizes.

V1.0

Scolmore International Ltd, 1 Scolmore Park, Landsberg, Lichfield Road Ind. Estate, Tamworth, Staffordshire, B79 7XB

Telephone: 01827 63454

E-mail: sales@scolmore.com, technical@scolmore.com

Facsimile: 01827 63362

Website: www.scolmore.com

GRIDPRO Interchangeable Plates

Product Dimensional Drawings (mm)

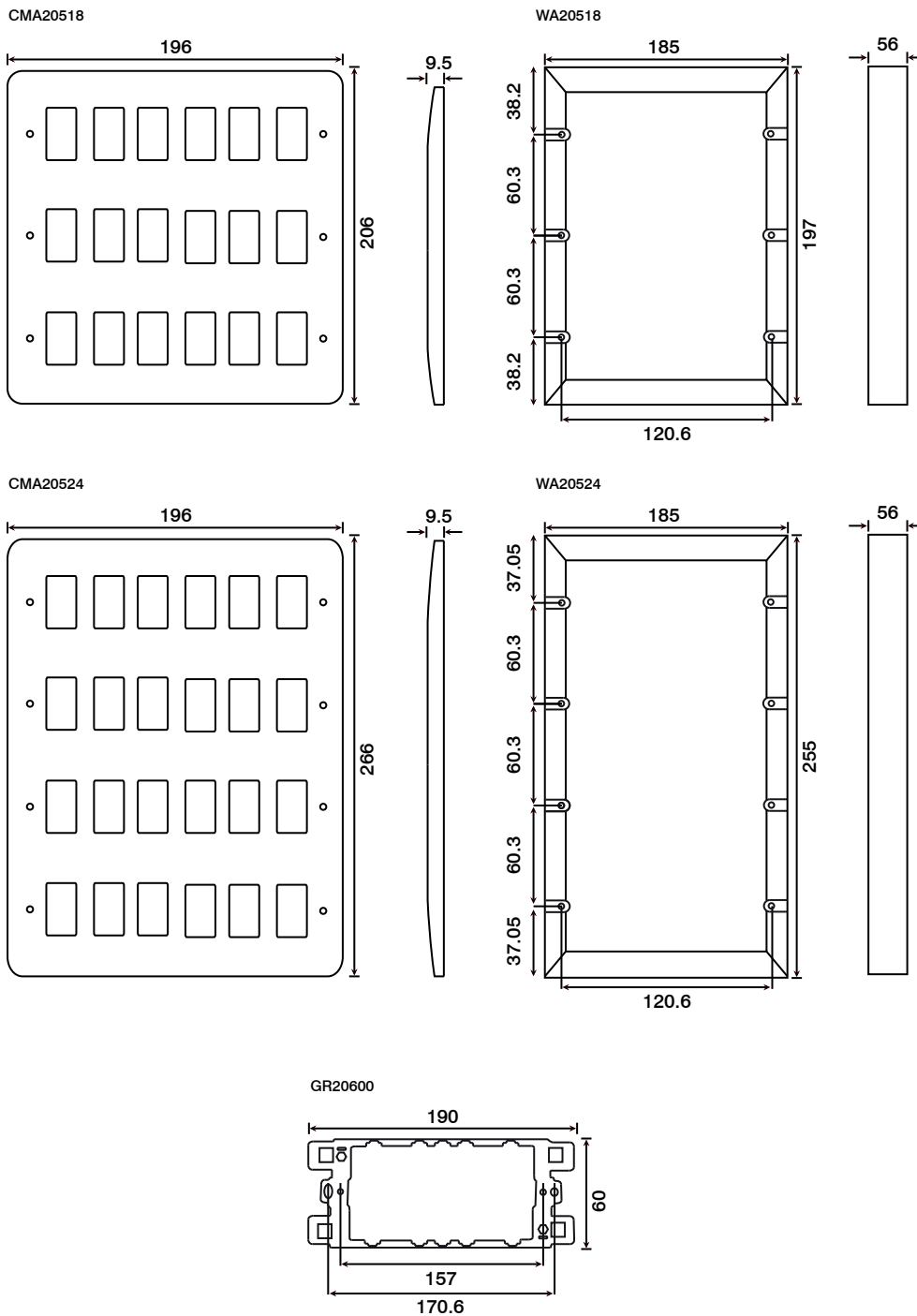

Errors & Omissions excluded. Specification is subject to change without notice. GR20600 to be used with all plate sizes.

V1.0

Scolmore International Ltd, 1 Scolmore Park, Landsberg, Lichfield Road Ind. Estate, Tamworth, Staffordshire, B79 7XB

Telephone: 01827 63454

E-mail: sales@scolmore.com, technical@scolmore.com

Facsimile: 01827 63362

Website: www.scolmore.com

GRIDPRO Interchangeable Plates

Technical Specification

GRIDPRO Interchangeable Plates

Material Composition	Front Plate: Urea GR20400 & GR20600 Mounting Yoke: Galvanised Steel Earth Terminal: Brass, Earth Strap: Mild Steel Back Boxes: Galvanised Steel
Cable Size	Dependent on modules fitted
Back Box Depth	Dependent on modules fitted
Modular	Yes
Warranty	20 Years
Anti Microbial Certified	Yes
IP Rating	IP20
Operational Temperature	-5° to +40°C
Standards	BS 5733 : 2010 + A1 : 2014, Modified ISO 22196 BS 4662: 2006 + A1: 2009 (Back Boxes)

Additional Information

Ensure that the mains supply is isolated before commencing installation and refer to the circuit diagram with the relevant product.

Bare earth cables must always be covered with appropriate sleeving and wired to the earth terminal.

All white moulded accessories are manufactured using Urea Formaldehyde, which has similar inherent properties to antimicrobial additives that inhibit the growth of infectious diseases. All products were independently tested and achieved a 99.9% kill rate across all four types of the strains of bacteria - MRSA, E-Coli, Salmonella, and Klebsiella Pneumoniae.

CMA20506 & CMA20508 requires (2x) GR20400 3-4 Module Mounting Yokes. These plates are designed to be used with specified back box WA512.

CMA20509 & CMA20512 requires (3x) GR20400 3-4 Module Mounting Yokes. These plates are designed to be used with specified back box WA518.

CMA20518 requires (3x) GR20600 6 Module Mounting Yokes. These plates are designed to be used with specified back box WA20518.

CMA20524 requires (4x) GR20600 6 Module Mounting Yokes. These plates are designed to be used with specified back box WA20524.

Interchangeable with modules in the GRIDPRO system. **GRIDPRO®**

GRIDPRO

CLICK
MODE

Scolmore
GROUP

Scolmore International Ltd
1 Scolmore Park: Landsberg
Lichfield Road Industrial Estate
Tamworth, Staffordshire B79 7XB

t: 01827 63454
f: 01827 63362
e: sales@scolmore.com
w: www.scolmore.com

EU DECLARATION OF CONFORMITY

1. *Issuer Name* Scolmore International Limited
2. *Issuer Address* 1 Scolmore Park, Landsberg,
Lichfield Road Industrial Estate,
Tamworth, Staffordshire, B79 7XB
3. *Object(s) of Declaration* Mode Range
- a. *Group* GRIDPRO Interchangeable Plates
- b. *Model No.* CMA20401, CMA20402, CMA20403, CMA20404, CMA20506, CMA20508,
CMA20509, CMA20512, CMA20518, CMA20524

4. *The object of the declaration described above is in conformity with the requirements of the following Legislations:*

5. *All products contained within the aforementioned comply with the relevant standards and requirements listed below.*

BS 5733 : 2010 + A1 : 2014

6. *I hereby declare that the equipment named above has been designed to comply with the relevant sections of the above referenced specifications. The unit complies with all applicable Essential Requirements of the Directives.*

In conjunction with the above all manufacture and process controls are in accordance with ISO 9001:2008.

This declaration has been issued under the sole responsibility of the manufacturer, signed at, for and on behalf of: Scolmore International Limited

R Turner

Ross Turner - Technical Support Engineer